

Enterprise IP Phone SIP-T20P

HD 



About This Guide

Thank you for choosing this Enterprise IP Phone which is especially designed for power users in the office environment. It features fashion and sleek design, abundant telephony applications, broad interoperability with the popular 3rd party VoIP products, fulfilling the VoIP deployment needs from enterprise and ITSP.

In this User Guide, you will find everything you need to quickly use your new phone. Be sure to verify with your system administrator that your network is prepared for configuring your IP phone. As well, be sure to read the Packing List section in this guide before you set up and use the phone.

Declaration of Conformity



Hereby, it's declared that this phone is in conformity with the essential requirements and other relevant provisions of the CE, FCC.

CE Mark Warning

This is a class B device, in a domestic environment; this product may cause radio interference, in which case the user may be required to take adequate measures.

WEEE Warning



To avoid the potential effects on the environment and human health as a result of the presence of hazardous substances in electrical and electronic equipment, end users of electrical and electronic equipment should understand the meaning of the crossed-out wheeled bin symbol. Do not dispose of WEEE as unsorted municipal waste and have to collect such WEEE separately.

Tables of Contents

Getting Started..... - 1 -

Packing List	- 1 -
Assembling the Phone.....	- 2 -
Configuration and Registration.....	- 4 -
Configuring via Web Page	- 4 -
Configuring via keypad.....	- 5 -

Overview - 6 -

Keypad Instruction.....	- 6 -
LED Instruction.....	- 7 -
Icon Instruction.....	- 8 -
User Interface.....	- 8 -

Customizing Your Phone..... - 10 -

General Settings.....	- 10 -
Phone Status.....	- 10 -
Language.....	- 10 -
Time and Date.....	- 11 -
Keypad Lock.....	- 12 -
Audio Settings.....	- 12 -
Volume.....	- 12 -
Ring Tones.....	- 13 -
Codec Selection.....	- 14 -
Contact Management.....	- 15 -
Edit/Add/Delete Contact.....	- 15 -
Import/Export Contact list.....	- 15 -
Other Settings.....	- 16 -
Dial Plan.....	- 16 -
Dial Now.....	- 17 -
Block Out.....	- 18 -

Using the Basic Call Functions..... - 19 -

Making a call.....	- 19 -
Call Devices.....	- 19 -
Call Methods.....	- 19 -
Answering a call.....	- 19 -
Answering an incoming call.....	- 19 -
Denying an incoming call.....	- 20 -

Call Forward	- 20 -
During an Active Call	- 20 -
Mute	- 20 -
Call Hold	- 20 -
Call Waiting	- 21 -
Call Transfer.....	- 21 -
3-way Conference	- 22 -
Voicemail	- 22 -

Using the Advanced Phone Functions..... - 24 -

Account Setting.....	- 24 -
TLS	- 24 -
Network Setting	- 25 -
PC Port Setting.....	- 25 -
VLAN Setting	- 26 -
HTTPS	- 27 -
Maintenance Tasks	- 27 -
Administrator Mode.....	- 27 -
Administrator/User Password	- 28 -
Reboot.....	- 28 -
Reset to Factory	- 28 -
Firmware Update.....	- 29 -
Decryption.....	- 30 -
System Log Export.....	- 31 -
Tone Settings.....	- 31 -

Trouble Shooting - 33 -

Getting Started

Packing List

The following components are included in your package:

- Enterprise IP Phone

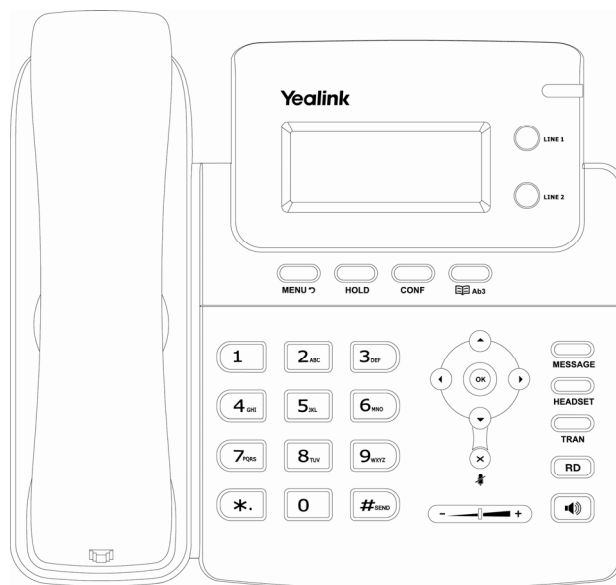

- Phone Stand

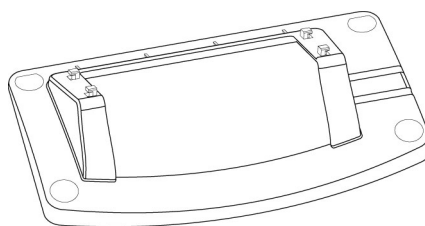

- Power Adapter

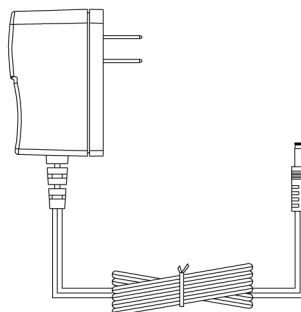

- Handset & Handset Core

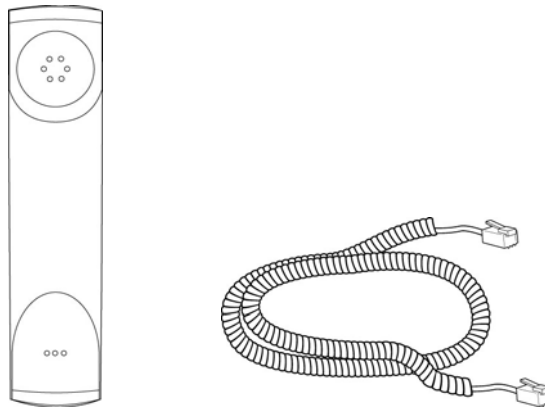

- Ethernet Cable

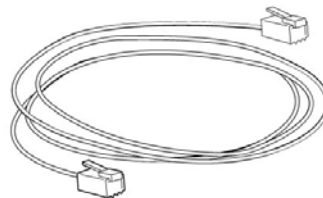

- Quick Installation Guide & Quick Reference

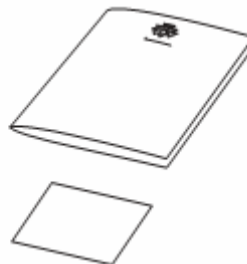

Check this list before installation to ensure that you have received each item. If you are missing any items, contact your IP phone reseller.

Assembling the Phone

This section introduces how to assemble the phone with the components in the packing list:

- Attach the stand;
- Connect Handset and Headset;
- Connect Network and Power.

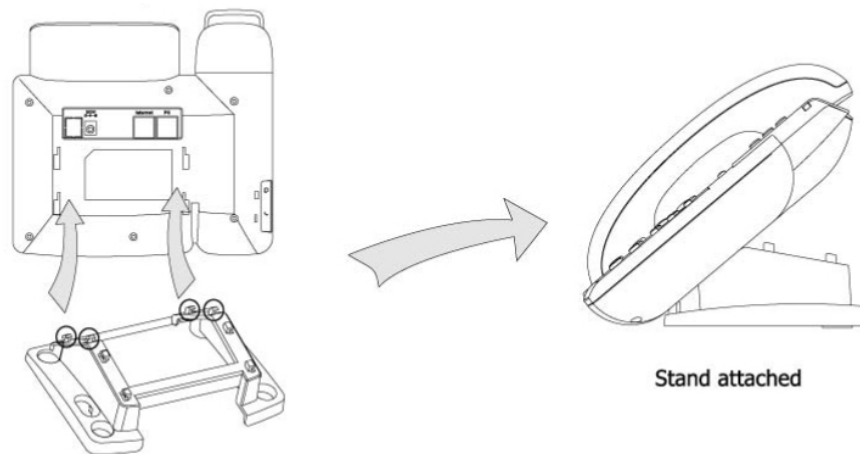
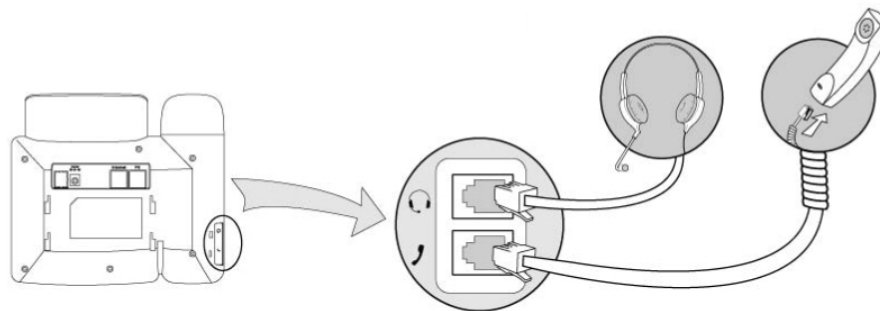
1) Attach the Stand, as shown below:**2) Connect Handset and Headset, as shown below:****Note:**

Headset is not provided in the packing list. Please contact your distributor for more information.

3) Connect Network and Power

There are two ways for network and power source connections. You can either connect the phone to the AC Power directly using the power adapter or to a PoE compliant switch or hub. Your system administrator will advise you on which one to use.

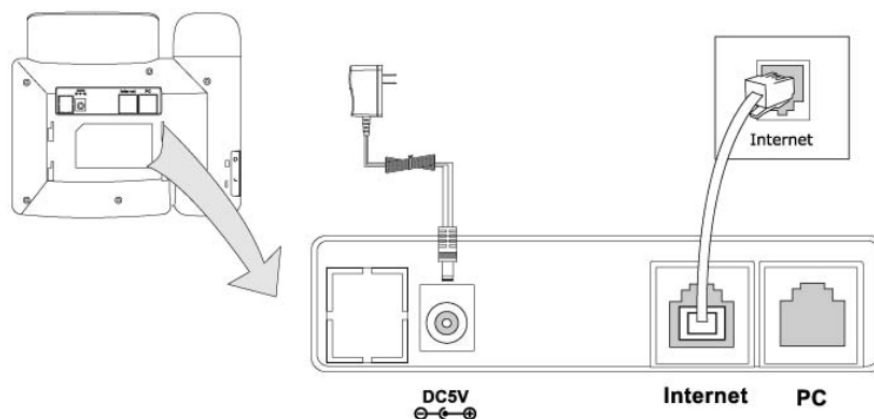

Note:

1. If inline power is provided, do not install AC adapter. Make sure the Ethernet cable and switch/hub are PoE compliant.
2. The Internet Port can be also connected to Hub/Switch/IP PBX or other internet devices.

The phone can also share the network connection with other network devices such as PC. Connect the phone's PC port and computer's Network Port together using an Ethernet cable, shown as below:

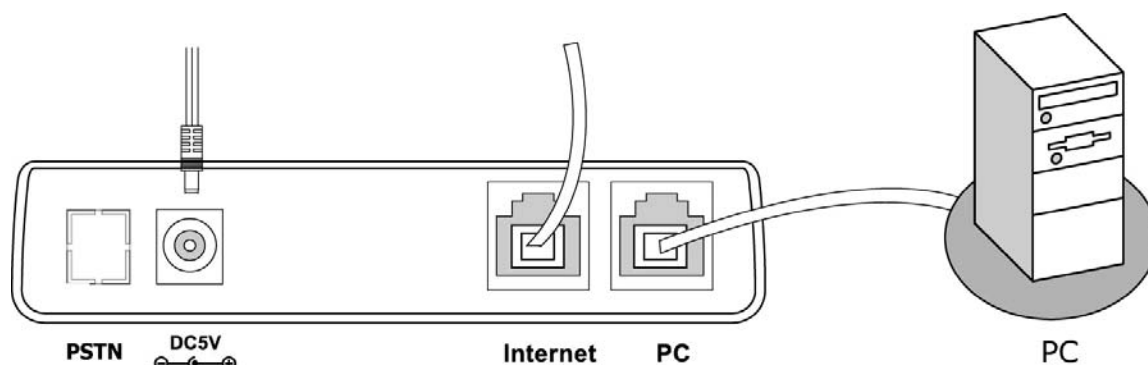

Configuration and Registration

If you are administrator, you need to do some simple configuration to make the phone work. If not, please contact with your internet administrator or service provider for more details.

Configuring via Web Page

Press OK button on the keypad of the phone to enter the status page and find out the IP address of IP phone. Enter it (for example <http://192.168.3.28>) into the address bar of web browser. The default login name and password are both "admin".

Note:

Please locate your PC in the same network segment of IP phone (192.168.3.X) to access the web configuration page. Please consult your system administrator for help.

Network Settings

Choose Network->Internet Port (WAN) .

DHCP: By default the phone attempts to contact a DHCP Server in your network in order to obtain its valid network settings, e.g. IP address, sub mask, gateway, DNS server, etc.

Static IP Address: If your phone cannot contact a DHCP Server for any reason, you need to enter the network settings manually via Static IP Address. Please contact your internet administrator for more details.

PPPoE: If you are using the xDSL Modem, you can connect your phone to the internet via PPPoE mode. Please contact your ISP for the User **Name** and **Password** for internet access.

Note:

Using the wrong network parameters may result in inaccessibility of your phone and may also have an impact on your network performance. Please contact your network administrator.

Account Settings

The phone attempts to register to the SIP server using the account/registrar data provided by the automatic or manual initialization.

Choose Account, you will find the following parameters:

Field	Description
<i>Register Status</i>	It shows the register status of the phone.
<i>Line Active</i>	You can choose on/off to enable/disable the account respectively.
<i>Label</i>	It is showed on the LCD for users to identify the account.
<i>Display Name</i>	It is showed as Caller ID when making a phone call.
<i>Register Name</i>	It is authenticated ID for authentication, provided by ISP.
<i>User Name</i>	User account information, provided by VoIP service provider.
<i>Password</i>	It is provided by ISP for registration.
<i>SIP Server & Port</i>	Server for registration, provided by ISP.

Note:

Should the IP PBX (SIP registrar) require an authentication, you will be prompted to enter the correct password. Make sure you are using the appropriate input method or enter the password via the web user interface.

Configuring via keypad

Network Settings: Press MENU->Settings->Advanced->Network->WAN Port/PC Port /VLAN/Web Server to enter the internet relating configuration page.

Account Settings: Press MENU->Settings->Advanced->Accounts->OK to configure the account settings.

You can refer to the above "Configuring via Web Page" for the parameter details.

Overview

Keypad Instruction

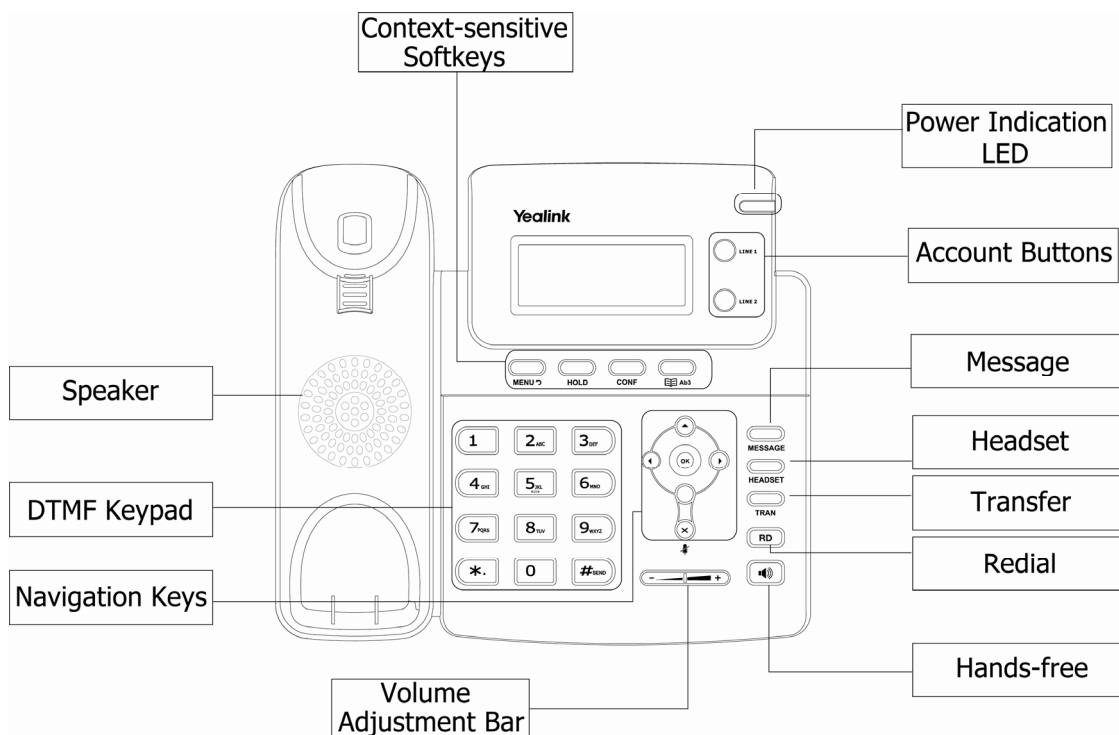

You can check the following list which introduces the IP phone's keypad in details:

Power Indication LED

It will show the power status, it will be on if the phone is powered, off if the phone is not powered.

Context-sensitive Softkeys

The screen will display labels for these keys, to identify their context-sensitive functions.

Account Buttons

This buttons are used to active up to the two user accounts.

DTMF Keypad

Use the DTMF hard keys to enter numbers, letters and special characters. Depending on the selected input mode, you can enter digits, lower / upper case or special characters.

Navigation Keys

Use the navigation keys to navigate in the display menus and confirm/cancel actions.

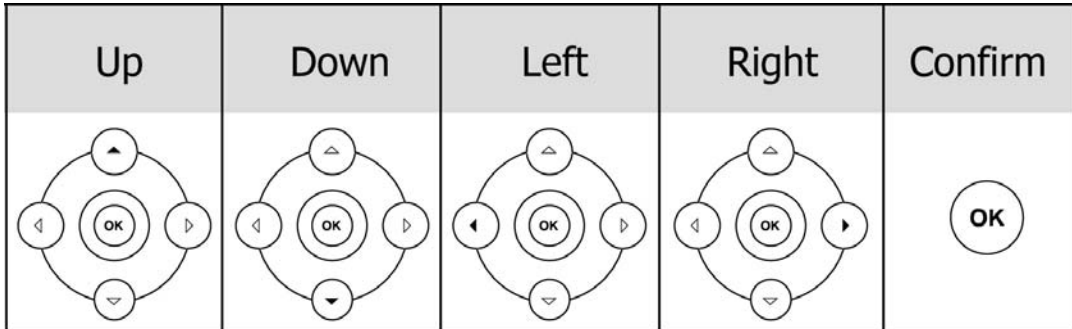

Audio Device Control Keys

Use the audio device control keys to perform the following actions depending on your phone type:

 : Adjust the volume of the handset, headset, speaker and ring tone;

 : Allows for hands-free communication during calls;

 : Place and receive calls through an optionally connected headset;

 : Mute audio transmission locally during calls;

Hard Feature Keys

 : Allow users to access the voicemail directly;

 : Forward the current call to a third party;

 : Dials the most recently dialed number;

LED Instruction

Table 1 Account Button LEDs











LED Status	Description
Steady green	The account is active
Blinking green	There is an incoming call to the account
Off	The phone is in idle status whatever registered /unregistered

Table 2 Power Indication LED

LED Status	Description
Steady green	Power on
Off	Power off

Icon Instruction

The IP Phone displays different kinds of icons on its LCD, you can refer to the following table for their meanings:

Icon	Description
	Flashes when the internet is disconnected
	Missed calls
	Call in
	Call out
Ab3	Input Method: all letters and numbers
123	Input Method: numbers
abc	Input Method: letters in lower case
ABC	Input Method: letters in upper case
	Call mute
HOLD	Call hold
	Voicemail
	Call forward
	Auto answer
	In handset mode
	In headset mode

User Interface

There are two ways to customize specific options on your phones:

1. Using keypad and display on the phone.
2. Using Web user interface in an Internet browser from your PC; please refer to "Configuration and Registration" to get into the Web interface.

In many instances, it is possible to use both the user interfaces to operate the phone and change settings; some, however, are only possible via a phone or web user interface. Please refer to the following table for differences:

Phone Options	Phone UI	Web UI
Status		
--IP Address		√
--MAC Address		√
--Firmware	√	√
--Network		√
--Phone		
--Accounts		
Call Features		
--Forward	√	
--Call Waiting	√	
--Auto Answer	√	
--"#" as send	√	√
--Hot Line	√	
--Dial Plan		
--Dial Tone		
Basic Phone Functions		
--Language	√	
--Time & Date	√	
--Ring Tone	√	√
--Phone Volume	√	
Advanced Phone Functions		
--Accounts	√	
--Networks	√	
--Lock	√	
--Reset To Factory	√	
--Set Admin Password	√	√
--Voice		
--Codecs		
--Echo Cancellation etc		
--Update		
Other Features		
--Message	√	√
--History	√	
--Address Book	√	

Note:

The above table only indicates most of phone functions rather than all of them. Please refer to the relating parts for more details.

User and Administrator Mode

Your phone can be used in user or administrator mode. Administrator mode is the default setting with full configuration rights. The default administrator password is **admin**.

Customizing Your Phone

General Settings

Phone Status

You can view the status of your phone using the Phone interface or the Web interface. This option allows you to review:

- IP address;
- MAC address;
- Firmware;
- Network status: Mac, WAN Type, WAN IP, WAN Mask, LAN Type, LAN IP, LAN Mask, Gateway, Pri DNS and Sec DNS;
- Phone: Product, Hardware, Firmware, Product ID and MAC;
- Accounts: The 2 SIP accounts status;

To check the Phone Status via Phone interface:

- 1) Press OK button directly, choose the Status option.
- 2) Use the navigation keys to scroll through the list and check the specific one.

1. IP-Addr: 192.168.3.28

To view the Phone Status via Web interface:

Open the web browsers and input the IP Address `http://WAN-ip-address`; Enter the account and password (default account and password are both "admin"), choose Status directly to check the status.

Language

The default Phone interface language is **English**. The Web interface language depends on your computer Operation System. It will automatically match the language with your computer.

It also supports French, German, Spanish, Italian, Polish, Turkish, Portuguese, etc. You can change the language for the phone user interface and the web user interface independently from each other.

Note:

All languages may not be available for selection. The available languages depend on the language packs currently loaded to the IP phone. Please contact with your system administrator for more information about loading language packs.

To change the language via Phone interface:

- 1) Press MENU->Settings->Basic ->Language.
- 2) Scroll through the list of available languages.
- 3) Press OK button when the desired language is highlighted. The language appears on the graphic display will be changed to the one you choose.

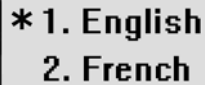

* 1. English
2. French

- 4) Press MENU key to return to the previous screen.

Time and Date

The time and date appears on the idle screen of the IP phone. If the phone can not obtain a time and date from the call server, please contact your system administrator if the time or date is incorrect. You can set the time manually or via the SNTP server which is used to synchronize the time.

To change the Time and Date via the Phone interface:

- 1) Press MENU->Settings->Basic->Time & Date.
- 2) If SNTP Time is chosen, the phone will automatically get the time from the specific NTP Server. Use the navigation keys to highlight the specific options and do the relating changes. You can set the Time Zone, NTP Server1/Server2, and Daylight respectively.



4. Daylight
◀ *Disable ▶

- 3) If Manual Setting is chosen, the time can be set manually. Use the navigation keys to highlight the option and enter the specific date and time.



1. Date[D-M-Y]:
07-04-09

- 4) Press OK button, the time appears on the idle screen will be changed. Or press MENU key to return to the previous screen.

To change the Time and Date via the Web interface:

Choose Phone->Preference to do the relating changes. You can also change the Update Interval which specifies the time frequency that the phone refreshes the time automatically. Please refer to the instruction above for the parameters' detail.

Note:

The default time zone is **+8 China, Philippines, Malaysia**, Daylight Saving Time is disabled.

Keypad Lock

You can lock the keypad of your phone when you are temporarily not using it. This function helps you to protect your phone from unauthorized use. You can lock the following specific keys:

- MENU Keys:* The MENU softkeys can not be used until unlocked. You can not access the menu of the phone.
- Function Keys:* The hard function keys can not be used until unlocked. You can not access the MESSAGE, HEADSET, CONF, HOLD, TRAN, RD Keys.
- Talk Call Only:* All of the keys can not be used until unlocked. You can only use the phone to answer the incoming calls.

To enable keypad lock via Phone interface:

- 1) Press MENU->Settings->Advanced, enter the password, and then press OK button.
- 2) Choose Lock->OK.
- 3) Use the navigation key to highlight the one you want to lock.



- 4) Press OK button to active the change, or MENU to return to the previous screen.

To unlock the phone via Phone interface:

- 1) Press MENU key, you are prompted for the password.
- 2) Enter the password, and then press OK button, the phone is unlocked.

To enable keypad lock via Web interface:

Choose Phone->Preference to do the relating changes. Please refer to the instructions above for the parameters' detail.

Note:

1. The default password for unlock is **admin**.
2. Users can make emergency calls when the phone is locked.

Audio Settings

Volume

You can adjust the volume of handset/speaker/headset.

To adjust the volume when you are not in an active call:

- 1) Press MENU->Settings->Basic.
- 2) Scroll to Phone Volume, and press OK button, highlight the one you want to adjust the volume, use the Volume Adjustment Bar or navigation keys to adjust the volume.



- 3) Press OK button to save the contrast change or MENU key to cancel.

To adjust the volume when you are in an active call:

When Handset/Headset/Hands-free mode is activated, press the Volume Adjustment Bar to a comfortable level.



Note:

The volume can only be adjusted via Phone interface.

Ring Tones

You can adjust the type and volume of the ring tone.

To adjust the Ring Tone Type via Phone interface:

- 1) Press MENU->Settings->Basic.
- 2) Scroll to Ring Tone, and press OK button.
- 3) Use the navigation keys to highlight the specific one.

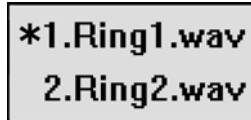

- 4) Press OK button to save the contrast change or MENU to cancel.

To adjust the volume via Phone interface:

- 1) Press MENU->Settings->Basic->OK.
- 2) Scroll to Phone Volume->Ring Vol, use the Volume Adjustment Bar or navigation keys to adjust the volume.



- 3) Press OK button to save the contrast change or MENU key to cancel.

You can also adjust the ring tone volume by the following way:

When the phone is in idle status, press the Volume Adjustment Bar to a comfortable level.



To change the Ring Tone Type via Web interface:

Choose Phone->Preference->Ring Type, highlight the specific one in the scroll-down menu, click confirm button to update the change. You can also delete the specific one by clicking the Delete button.

To upload the new Ring Tone via Web interface:

- 1) Click Browse button to choose the specific ring tone file.
- 2) Click Upload button to upload the file, and then Confirm to save the change.

Note:

The ring tone file format must be in 16bits WAV format (via Ulaw Compression), 8K sample rate (monophony). Blank or other special characters can not be included in the file name.

Codec Selection

The IP phone supports the following voice codecs:

G.722, G.723_53, G.723_63, G.726-16, G.726-24, G.726-32, G.726-40, G.729, PCMU, and PCMA.

You can enable/disable the desired codecs via Web interface. Please contact your System Administrator for more details about the codecs.

To enable/disable the codecs:

- 1) Choose Account-> Codecs.

The screenshot shows the Yealink web interface for configuring an account. The 'Account' tab is selected, and the 'Codecs' section is expanded. Two lists are shown: 'Disable codecs' and 'Enable codecs'. The 'Disable codecs' list contains G723_53, G723_63, G726-16, G726-24, G726-32, and G726-40. The 'Enable codecs' list contains PCMU, PCMA, G729, and G722. Navigation buttons (>>, <<, up, down) are visible between the lists. At the bottom, there are 'Confirm' and 'Cancel' buttons. A 'NOTE' section on the right provides details for various parameters like Display Name, Register Name, User Name, NAT Traversal, Proxy Require, Codecs, and Advanced.

- 2) Use the navigation keys to highlight the desired one in the Enabled/Disable Codecs list, and press the >> / << to move to the other list.
- 3) Click Confirm button to save the change.

Note:

Codec Selection can be only set via Web interface.

Contact Management

Edit/Add/Delete Contact

You can store a large number of contacts in your phone's directory. You can add, edit, delete, dial, or search for a contact in this directory.

To add a contact via Phone interface:

- 1) Press MENU->Address Book->OK.
- 2) Press Up/Down navigation key to ADD page, Press OK button to start adding a new contact, enter Name, phone number of the contact by the keypad. Use the 123 to select between numeric and upper/lower case alphanumeric modes.



- 3) Press OK button to add the contact, or MENU key to cancel the change.

To edit/delete a contact via Phone interface:

- 1) Press MENU->Address Book ->OK.
- 2) Use the Up/Down navigation key to highlight the contact you want to edit/delete, then press left/right navigation keys to EDIT/DEL page.



- 3) Make the desired changes, press OK button, or press MENU return to previous menu.

To add/delete/edit the contact list via the Web interfaces:

Choose Contacts and then do the relating changes. Please refer to the instruction above for the parameters' detail.

Import/Export Contact list

Import/Export Contact List via Web interface:

- 1) Choose Contacts.

Yealink
EASY VOIP

Status Account Network Phone **Contacts** Upgrade Security

Contact

Index	Name	Number	Line
1			
2			
3			
4			
5			
6			
7			
8			
9			
10			

Page: 1 Prev Next Delete

Name:
 Number:
 Line: Auto

Add Modify Search

Please select the contacts list file

Import Export

NOTE

Add Contact/Blacklist
Put in the informations about contact. User shouldn't leave contact name blank.

Delete Contact/Blacklist
Select the contact you want to delete in the grid, and then press the button Delete to submit.

Move to Contact/Blacklist
Choose one list you want to move in the grid, and press the button move to Contact/Blacklist to move it.

Import
Browse the file in XML format.

Export
Click Export button and create a file with he name you like.

- 2) Browse the specific contact list file in .doc format, and then click Import button. The imported contact lists will be showed in the Address Book.
- 3) Click the Export button to export the contact list.

Note:

Import/Export Contact List can be only set via Web interface.

Other Settings

Dial Plan

A dial plan establishes the expected number and pattern of digits for a telephone number. This includes country codes, access codes, area codes and all combinations of digits dialed. For example if you set the *Prefix* as 0 and *Replace* as 0086 (Chinese country code), when you dial 05702000 out, the number will be replaced by 00865702000 automatically.

To set a Dial Plan via the Web interface:

- 1) Choose Phone->Dial Plan->Replace Rule.

Yealink
EASY VOIP

Status | Account | Network | **Phone** | Contacts | Upgrade | Security

Preference | Features | Voice | Ring | Tones | Dial Plan

Replace Rule >>

Index	Prefix	Replace
1		<input type="checkbox"/>
2		<input type="checkbox"/>
3		<input type="checkbox"/>
4		<input type="checkbox"/>
5		<input type="checkbox"/>
6		<input type="checkbox"/>
7		<input type="checkbox"/>
8		<input type="checkbox"/>
9		<input type="checkbox"/>
10		<input type="checkbox"/>

Prefix Replace

Dial-now>>
Area Code>>
Block Out>>

NOTE

Digit 0-9 *
Identifies a specific digit (do not use #).

[digit-digit]
Identifies any digit dialed that is included in the range.

[digit-digit,digit]
Specifies a range as a comma separated list. Please notice that only block out rule support this method.

x
Matches any single digit that is dialed.

.
Matches an arbitrary number of digits.

- 2) Enter the desired *Prefix* and *Replace*.
- 3) Press Add button to save the changes.
- 4) You can also delete a specific one from the dial plan list by pressing Del button.

Note:

Please contact with your system administrator for the country/area code if you want to set the dial plan.

Dial Now

Dial-now enables you to define the specific length of any number/letter in advance(for example xxx), next time when users dial out the 123 whose length matches the Dial-now rule, the phone will dial out 123 immediately without pressing Send button.

To set a Dial Plan via the Web interface:

- 1) Choose Phone-> Dial Plan->Dial Now.

Replace Rule >>

Dial-now>>

Index	
1	<input type="checkbox"/>
2	<input type="checkbox"/>
3	<input type="checkbox"/>
4	<input type="checkbox"/>
5	<input type="checkbox"/>
6	<input type="checkbox"/>
7	<input type="checkbox"/>
8	<input type="checkbox"/>
9	<input type="checkbox"/>
10	<input type="checkbox"/>

Dial-now Rule

Area Code>>

Block Out>>

NOTE

Digit 0-9 *
Identifies a specific digit (do not use #).

[digit-digit]
Identifies any digit dialed that is included in the range.

[digit-digit,digit]
Specifies a range as a comma separated list. Please notice that only brock out rule support this method.

x
Matches any single digit that is dialed.

.
Matches an arbitrary number of digits.

- 2) Enter the desired "x/."
- 3) Press Add button to save the changes.
- 4) You can also delete a specific one from the dial plan list by pressing Del button.

Note:

x represents any numbers; . represents any letters.

Block Out

The specific phone numbers can be forbidden to be call out from your IP phone.



- 1) Choose Phone->Dial Plan->Block Out.
- 2) Enter the phone number and click Add button to save the changes, or choose the specific one in the list, click Del button to delete the record.
- 3) You can not dial out the number from your IP phone unless it is removed from the Forbidden List.

Using the Basic Call Functions

Making a call

Call Devices

You can make a phone call via the following devices:

- 1) Pick up the handset,  icon will be showed in the idle screen.
- 2) Press the Speaker button, icon  will be showed in the idle screen.
- 3) Press the Headset button if the headset is connected to the Headset Port in advance.
The icon  will be showed in the idle screen.

You can also dial the number first, and then choose the method you will use to speak to the other party.

Call Methods

You can press an available line button if there is more than one account, then

- 1) Dial the number you want to call, or
- 2) Go to Address Book, use the navigation button to highlight your choice, or
- 3) Go to History, use the navigation button to highlight your choice (press Left/Right button to chose All Calls, Missed Calls, Dialed Calls, Received Calls and Forwarded Calls) or
- 4) Press the RD button to call the last number called.
- 5) Press the SEND button to dial out if necessary.



Answering a call

Answering an incoming call

- 1) If you are not on another phone, lift the handset using, or press the Speaker button to answer it using the speakerphone, or press the headset button to answer it using the headset.
- 2) If you are on another call, press the LINE X key or OK button to answer it.



During the conversation, you can alternate between Headset, Handset and Speaker phone by pressing the corresponding buttons or picking up the handset.

Denying an incoming call

Press MENU key to deny the incoming call directly.

Call Forward

This feature allows you to forward an incoming call to another phone number e.g. a cell phone or voice mailbox. The display showed  icon.

The following call forwarding events can be configured:

- *Off:* Call forwarding is deactivated by default.
- *Always:* Incoming calls are immediately forwarded.
- *Busy:* Incoming calls are immediately forwarded when the phone is busy.
- *No Answer:* Incoming calls are forwarded when the phone is not answered after a specific period.
- *Busy/No Answer:* Incoming calls are forwarded not matter the phone is busy or not answered.

To configure Call Forward via Phone interface:

- 1) Press the following keys: MENU->Features->OK->Call Forward->OK.
- 2) There are 5 options: Always Forward, Busy Forward, No Answer Forward, Busy/No Answer Forward, Cancel Forward.
- 3) If you choose one of them (except Cancel Forward), enter the phone number you want to forward your calls to. Then press OK to save the changes.

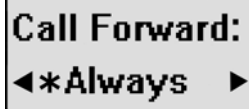

To configure Call Forward via Web interface:



Choose Phone->Features->Forward to do the relating changes. Please refer the above configuration information.

During an Active Call

Mute

This function allows you to mute the microphone of the active audio device during a call; you can not be heard by the other party. You can still hear all other parties while mute is enabled.

To mute/resume the conversation:

Press  button during the conversation, the icon  will be shown on the LCD. Press  again to get the microphone return to normal conversation.

Call Hold

This call function allows you to place an active call on hold. In this case your IP PBX

might play a melody or message to the other party while waiting. Other calls can be received and made while having a call on hold.

To hold/resume a call:

- 1) Press the HOLD button to put your active call on hold.
- 2) If there is only one call on hold, press the HOLD button again to retrieve the call.

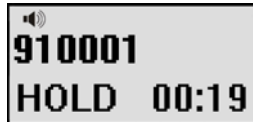

- 3) If there is more than one call on hold, press the Up/Down button to highlight the call, then press the HOLD button again to retrieve the call.

Note:

When you are under the call hold status, putting down the handset, the conversation will go on over the speaker instead of hanging up the call.

Call Waiting

This call feature allows your phone to accept other incoming calls to an extension already in an active call.

To enable/disable Call Waiting via Phone interface:

- 1) Press MENU->Features->Call Waiting->OK button.
- 2) Use the navigation keys to active/inactive call waiting.

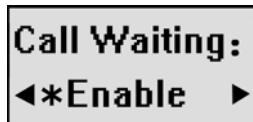

- 3) Press OK button to save the changes, or MENU to return to the previous menu.

To enable/disable Call Waiting via Web interface:

Choose Phone->Function->Call Waiting to do the relating changes.

Call Transfer

You can customize your phone so that incoming calls are transferred directly to a third party such as another extension, mobile phone number, etc. There are two ways to transfer the call: Blind Transfer and Attended Transfer.

To Blind Transfer via Phone interface:

- 1) Press TRAN Button during the active conversation, the call will be on hold, there will be a dial tone. Dial the other telephone number.

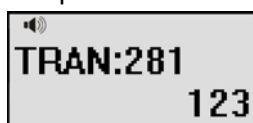

- 2) Press the MENU key to stop the call transfer operation before the call is answered.
- 3) Hang up to complete the transfer.
- 4) You will be disconnected from the call.

To Attended Transfer via Phone interface:

- 1) Press TRAN button during the active conversation, the call will be on hold, there will be a dial tone. Dial the second telephone number.
- 2) When the phone is answered, you can have a private conversation without the first person hearing it, then hang up to complete the transfer.
- 3) You will be disconnected from the call.

3-way Conference

You can establish a three-party conference, during the conversation three phone parties can communicate with each other.

To establish a conference:

- 1) Press the CONF button during an active call.
- 2) The first call is placed on hold. You will hear a dial tone. Dial the number to conference in, then press the SEND key.

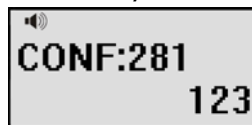

- 3) Press the MENU key to stop the conference in operation before the call is answered.
- 4) After the call is answered, the conference call will now include you and the other two parties.
- 5) Hang up to disconnect all parties.

Voicemail

Your voice mailbox messages, which are usually stored on a media server of your local or hosted VoIP telephony system, can be accessed from your phone.

New voice messages can be indicated both acoustically and visually as described below:

- The idle screen will indicate the new voice messages coming:

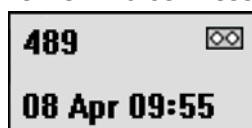

- The MESSAGE button will be lighted.

To configure the Voicemail code via Phone interface:

- 1) Press MESSAGE button to Voice Mail.
- 2) Use the navigation keys to highlight the Line you want to set, enter the code which the phone uses to connect to your system. Press 123 to choose the proper input method.

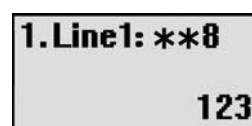

- 3) Press OK button to save the change, or press MENU to return to the previous menu.

Note:

Please contact your system administrator for the connecting code. Different systems have different codes.

To retrieve the new voicemail via the Phone interface:

- 1) Press the MESSAGE button directly.
- 2) You may be prompted to enter the password which is needed to connect to your VoIP telephony system. It depends on your system.
- 3) Your voice mailbox is called and you are able to listen to your new and old voicemails.

Note:

Before retrieving the new voicemail, please make sure that the connecting code has been set on the phone.

Using the Advanced Phone Functions

Account Setting

Please refer to the previous part "Configuration and Registration" for the basic account setting information. The following table lists the instruction of the field about the advanced Account Setting.

Field Name	Description
<i>UDP Keep-alive Message</i>	Defines whether to active the phone UDP Keep-alive mechanism. The default is Enabled.
<i>UDP Keep-alive Interval</i>	This parameter specifies how often the phone will send a packet to the SIP server. Default is 30 seconds.
<i>Login Expire</i>	This parameter specifies the time frequency that phone refreshes its registration. The default interval is 3600 seconds.
<i>Local SIP Port</i>	Local SIP port. The default value is 5060.
<i>RPort</i>	The parameter allows you configuring the proxy to send responses back to a particular address and port. The default is disabled.
<i>SIP Session Timer</i>	This document defines an extension to the Session Initiation Protocol (SIP). This extension allows for a periodic refresh of SIP sessions through a re-INVITE or UPDATE request. The refresh allows both user agents and proxies to determine if the SIP session is still active.
<i>Subscribe Period</i>	This parameter could set the period of the subscription. The default value is 3600.
<i>DTMF Type</i>	Select the DTMF type.

You can only configure these settings via Web interface.

- 1) Choose Account.
- 2) Select the desired account.
- 3) Choose Advanced to do the relating settings.

You can consult your system administrator for more information.

TLS

TLS(Transport Layer Security), an IETF standards track protocol(RFC 5246), was based on the earlier SSL specifications developed by Netscape Corporation.

Go to Account->Advanced, choose Transport option, in the pull-down menu, you can choose the TLS option, then click the Confirm button to save the change.

Account Account 1

Basic >>

Register Status	Unknown	
Line Active	<input type="checkbox"/> On	<input checked="" type="checkbox"/> Off
Label	<input type="text"/>	
Display Name	<input type="text"/>	
Register Name	<input type="text"/>	
User Name	<input type="text"/>	
Password	<input type="text"/>	
SIP Server	<input type="text"/>	Port:5060
Enable Outbound Proxy Server	Disabled	
Outbound Proxy Server	<input type="text"/>	Port:5060
Transport	UDP	
Backup Outbound Proxy Server	UDP TCP	Port:5060
NAT Traversal	TLS	
STUN Server	217.10.79.21	Port:10000
Voice Mail	<input type="text"/>	
Proxy Require	<input type="text"/>	
Anonymous Call	Disabled	
Anonymous Call Rejection	Disabled	

NOTE

Display Name
SIP service subscribers name which will be used for Caller ID display.

Register Name
SIP service subscribers Authenticate ID used for authentication.

User Name
User account information, provided by VoIP service provider.

NAT Traversal
Defines the STUN server will be active or not.

Proxy Require
A Special parameter just for Nortel server. If you login to Nortel server, the value should be: com.nortelnetworks.firewall

Codecs
Choose the codecs you want to use.

Advanced
The Advanced parameters for administrator.

Network Setting

PC Port Setting

Please refer to the previous part "Configuration and Registration" for the basic Network WAN setting information. The following table lists the instructions of the field about the Network PC Port Setting.

Field Name	Description
<i>As Bridge</i>	If you select the Bridge mode, then the two Fast Ethernet ports will be transparent.
<i>As Router</i>	If you select the Router mode, the SIP phone will work as a router
<i>IP address</i>	User could configure the PC port IP address.
<i>DHCP Server</i>	If you set the DHCP server on, the device connected to the PC port will get the IP address automatically between the start IP address and the end IP address. But if you select the bridge mode, the DHCP server can not work.
<i>Starting IP</i>	Indicate the range of the IP address
<i>End IP</i>	Indicate the range of the IP address

To configure PC Port settings via Phone interface:

- 1) Press Menu->Settings->Advanced.
- 2) Enter the password required, scroll to Network option, press OK button, select PC port, and press OK button to enter.

<p>*1. Bridge</p> <p>2. Router</p>
--

- 3) If you choose Bridge, it will return to the previous menu.
- 4) If you choose Router, you will be prompted to enter the IP, Netmask, DHCP Server Disable/Enable.
- 5) Press OK button to save the changes, or MEBU to return to the previous menu.

To configure PC Port via Web interface:

Choose Network->PC Port to do the relating configuration, you can set the starting and end IP address only via Web interface. You can consult your system administrator for more information.

VLAN Setting

VLAN is a group of hosts with a common set of requirements that communicate as if they were attached to the Broadcast domain, regardless of their physical location. The following table lists the instruction of the field about the VLAN Setting.

Field Name	Description
<i>QoS</i>	When the network capacity is insufficient, QoS could provide priority to users by setting the value.
<i>Local RTP Port</i>	Define the port for voice transmission.
<i>WebServer</i>	Users can choose the WebServer type: Disable, HTTP, HTTPS, or HTTPS & HTTP.

To configure VLAN settings via Phone interface:

- 1) Press Menu->Settings->Advanced.
- 2) Enter the password required, scroll to Network option, press ok button, select VLAN, press OK to enter.

<p>1. LAN Port</p> <p>2. PC Port</p>
--

- 3) Choose LAN Port, press OK button.
- 4) Set the VLAN Status, and input the VID Number, Priority.
- 5) Press OK button to save the settings, or MENU to return to VLAN menu.
- 6) Follow the same way to set the PC Port option.

To configure VLAN settings via Web interface:

Choose Network->Advanced to do the relating configuration. You can consult your system administrator for more information.

HTTPS

This IP phone can support HTTPS (Hypertext Transfer Protocol over Secure Socket Layer). Adding SSL layer under HTTP, in short, it is a security version of HTTP. Users can set this transmission mode via web page.

To configure HTTPS settings via Web interface:

Go to Network->Advanced, choose WebServer option, in the pull-down menu of Type field, choose the transmission mode, then click the Confirm button to save the changes.

The screenshot shows the Yealink web interface with the 'Network' tab selected and the 'Advanced' sub-tab active. The 'WebServer' section is expanded, showing the 'Type' dropdown menu set to 'HTTPS Only'. Other sections include VLAN (WAN and PC ports), Voice QoS, and Local RTP Port settings.

Section	Field	Value	Range
VLAN - WAN Port	Active	Enabled	
	VID	0	(0-4094)
	USR PRIORITY	0	
VLAN - PC Port	Active	Disabled	
	VID	0	(0-4094)
	USR PRIORITY	0	
Voice QoS	Voice QoS	40	(0~63)
	SIP QoS	40	(0~63)
Local RTP Port	Max RTP Port	11800	(0~65535)
	Min RTP Port	11780	(0~65535)
WebServer	Type	HTTPS Only	

NOTE: VLAN is a group of hosts with a common set of requirements that communicate as if they were attached to the Broadcast domain, regardless of their physical location. QoS: When the network capacity is insufficient, QoS could provide priority to users by setting the value. Local RTP Port: Define the port for voice transmission.

Note:

For more details of the HTTPS, you can consult with your system administrator.

Maintenance Tasks

Administrator Mode

The phone allows two modes to configure the phone:

- User Mode
- Administrator Mode

Administrator mode grants unlimited access to the phone configuration on both Web and Phone interface. User Mode is not able to access the settings on the Phone interface such as: Accounts, Network, Reset to Factory, other phone settings.

Administrator/User Password

Administrator mode grants unlimited access to the phone configuration on both web and phone user interface. The administrator/user password is used to access:

- Web interface along with user name.
- the advance settings of the phone such as Network, Account, Reset to Factory Settings via the Phone interface.

The default administrator password is **admin**. Meanwhile the user name for Web interface access is **admin**.

To change the administrator password via Phone interface:

- 1) Press MENU->Settings->Advanced->OK->Set Admin PWD->OK.
- 2) You are prompted to enter the old PWD, new PWD and Confirm PWD, Press abc to change the input method.

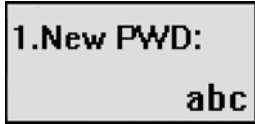

1.New PWD:
abc

- 3) Press OK button to confirm the change, or MENU to return to previous menu.

To change the administrator password via Web interface:

Choose Security, enter the old, new password and Confirm Password, choose Confirm button to save the changes, or Cancel button to cancel the changes.

Reboot

You should reboot the phone when you are challenged, e.g. after applying changes to the phone configuration.

To reboot via Web interface:

- 1) Choose Upgrade->Basic.
- 2) Click Reboot button.

Note:

You can only reboot from Web interface. Please do not power off during reboot, or it will cause the flash memory error.

Reset to Factory

You should reset the phone only in this case: the phone configuration was changed and the phone is not functioning anymore. To maintain the configuration of the phone, you need your system administrator or service provider's advice.

To reset to factory via phone interface:

- 1) Press MENU->Settings->Advanced.
- 2) You are prompted to enter the required password, the default one is **admin**.
- 3) Scroll to Reset Setting, press OK button.
- 4) You are prompted to confirm the change, press OK to reset to factory settings, or MENU to return to previous menu.

**Reset to
Factory ?**

- 5) It will take a few minutes to reset, please do not power off during resetting, or it will cause flash memory error.

To reset to factory via Web interface:

- 1) Choose Upgrade->Basic.
- 2) Click Reset button.

Note:

If you confirm all current setting changes including contact list, call history, account settings, etc will be lost, you need to export the configuration first if you still want to import the old configurations after reset. Or your phone must be configured a new manually unless mass provisioning is used!

To Export/Import the old configuration file via Web interface:

- 1) Choose Upgrade->Advanced, select Import/Export Config, click Export button to export the file to your local computer.
- 2) Choose Upgrade->Advanced, select Import/Export Config, click Browse button, select the specific configuration file in your local computer, click Import button.
- 3) It will take a few minutes to reset, please do not power off during resetting, or it will cause flash memory error.

Firmware Update

The phone is delivered with pre-installed firmware which allows operating your phone flawlessly. If you require updating the phone's firmware please contact your system administrator. You can only update the firmware via Web interface.

To update the firmware manually via Web interface:

- 1) Choose Upgrade->Basic->Browse, select the firmware file in your local computer.
- 2) Click Upgrade button to update the new firmware.
- 3) Please do not power off during the updating.

To update the firmware automatically via Web interface:

- 1) Choose Upgrade->Advanced, configure the relating settings: Custom Option, Custom Option Type, URL, Account, Password, Check New Config and ASE Key.
- 2) Click Confirm button, the phone will check the server for a new firmware in a specific time, and it updates automatically if there is new firmware.
- 3) You can also update the firmware immediately by pressing Autoprovision button.

The parameters of the Autoprovision:

Parameter	Description
<i>Update Protocol</i>	The phone can be updated via TFTP, FTP or HTTP.
<i>TFTP Server</i>	If you choose TFTP as protocol TFTP, you need to enter the TFTP server IP address and port.
<i>Check new config</i>	You can specific the period that your phone checks the new firmware from the server: Power on, Repeatedly, Weekly, Power on + Repeatedly, Power on + Weekly and Disabled.
<i>Scheduling</i>	You can specific the period in days which the phone checks and updates the new firmware, the range is 1-30 days.

Note:

1. Any power interruption during the following process will most likely lead to a flash memory error. As a result the system cannot boot up anymore. The procedure can be only conducted in Administrator Mode.
2. If the updating is failed, you can re-plug the power adaptor, and press the Speaker key for 3 seconds, the IP phone will enter the account configuration interface. Users can reconfigure the IP phone account information here, then press the OK button to save the changes.

Decryption

This IP phone can support y000000.cfg and mac.cfg files encryption and decryption for user authentication to realize security usage. If there are any encrypted y000000.cfg or mac.cfg files on the server, users can open the webpage of your IP phone. Go to Upgrade->Advanced, choose and fill in the Specified AES Key (for y000000.cfg) and Per-phone AES Key (for mac.cfg) option, then click the Confirm button to decryption the files and upgrade to the new version. Shown as below:

The screenshot shows the Yealink web interface with the 'Upgrade' tab selected. The 'Advanced' settings page is displayed, featuring several configuration fields and buttons. The 'Export System Log' option is highlighted, and the 'Export' button is visible. A 'NOTE' section on the right provides additional information about the 'Custom Option', 'AES Key', 'Click here to Autoprovision Now', 'Export/Import Config', and 'System Log' features.

Note:

You can ask your system administrator for the decrypt password.

System Log Export

If there are any errors happened in your phone, you can export the system log and send to your system administrator for diagnosis.

To export the System Log:

Choose Upgrade->Advanced, select Export System Log, click Export button to export the file to your local computer.

Tone Settings

You can define the frequency and time period of all the following tones:

- Dial
- Ring Back
- Busy
- Congestion
- Call Waiting
- Dial Recall
- Record
- Info
- Stutter
- Message
- Auto Answer

To edit the tone filed via Web interface:

- 1) Choose Phone->Tones.
- 2) Enter the frequency and time period(in ms) as the following format:
Frequency /Time Period (for example 400/200).
- 3) Press Confirm button to save the changes, Cancel to cancel the changes.

Note:

1. Please contact your system administrator for more information about the frequency and time period parameters. You can enter up to 8 groups for each tone.
2. If the frequency is set as 0, it means silence.

Trouble Shooting

I can not register to the server?

- 1) Check the IP address. If you set your WAN port in DHCP mode, please make sure that your DHCP server is on.
- 2) Check your gateway.
- 3) Check your DNS server.
- 4) Make sure your account information is the same as you have got from your ISP.
- 5) Check whether the SIP server is on.
- 6) Check the SIP register port, the default value is 5060.

I can't get the IP address?

- 1) Make sure you have plugged the Ethernet cable into the WAN port.
- 2) Make sure that the DHCP server is on, and there are available IP addresses in the server.
- 3) Try to set your WAN port to static IP client mode.

During a call, I can not hear any voice?

- 1) Make sure your handset is tightly connected with the phone.
- 2) Check whether you have muted the conversation or not.
- 3) Consult the outbound server details with your ISP.

Have DTMF problem?

- 1) Check which kind of DTMF you are using, and whether it is compatible with the server.
- 2) Consult the payload value with your ISP.

How to change the time?

Select the time zone or enter the time information manually on the webpage or the phone.

How to answer the incoming calls during a call?

If a call comes in when you are in a conversation, press the Answer key to answer the incoming call.

How to refuse incoming calls during a call?

You can turn off the function of call waiting, and then our phone will refuse all the incoming calls when you are in a conversation.

How to send SMS?

You could edit the SMS in the MENU-> Messages->Text Messages.

Note:

Make sure that the SIP server you have registered supports SMS function.

How to update the firmware?

- 1) Enter the webpage of your phone, go to Upgrade, then you can find the option "Select and Upgrade Firmware" at the bottom of the page.
- 2) Select the file to update, then click the Upgrade button.

Note:

Make sure the firmware you choose is provided by your service provider, or the device will probably crash after the update.

How to auto provision?

Consult the auto provision server address with your ISP.